

## Flicker Free Concealed Adaptor with Integrated LED Driver ( 3 Phase)

**SC18W180-450CG-4**



### Product Description

- different power range adjustable with DIP switch
- constant current LED driver
- output current: 180mA,250mA, 350mA and 450mA
- max output power 18W
- lifetime up to 50000 hours
- insulation Class: I,II
- temperature protection comply with EN61347-2-13 CE
- 5 years warranty
- The Class II symbol is just considered by driver, not by adaptor system.
- Track adapters can be used with Class III luminaires.
- Suitable for following tracks
  - NA Globaltrac pro
  - Eutrac 25101
  - Stucchi
  - Ivela
  - Unipro
  - Concord
  - Hoffmeister
  - further on request



### Performance

- Case: PC(polycarbonate), fire-protection rating: 94-V0 conformed with ROHS
- Color: black RAL9005 ( B ) ,grey RAL7040 ( G ) ,white RAL9016 ( W )
- Nipple color: black RAL9005 ( B ) ,grey RAL7040 ( G ) ,white RAL9016 ( W )
- Red copper alloy contacts
- 2KV surge
- ingress protection: IP20

### Product Characteristics

- The lamp control gear does not rely upon the luminaire enclosure for protection against accidental contact with live parts, the LED light source load can't be accessible.
- If the components are unsuitable for the connection of inductive loads, or de-rating for inductive loads if appropriate.
- It is the user's responsibility to ensure electrical, mechanical and thermal compatibility between the track system and luminaires attached to it.
- for LED lamps use only

### Protections:

- Over-load protection
- Short Circuit protection
- No-load protection
- Under-voltage protection

**Flicker Free Concealed Adaptor with Integrated  
LED Driver ( 3 Phase)**

**Specifications**

Rated supply voltage	220-240V
Input voltage	198-264VAC or 200-250VDC
Mains frequency	50-60Hz
THD (at 230 V, 50 Hz, full load)	< 20 %
Output current tolerance	±5%
Output current ripple (at 230 V, 50 Hz, full loaded)	$\leq \pm 5\%(I_{max}-I_{min})/(I_{max}+I_{min})$
Inrush Current	5.2A/460 $\mu$ s
Connected quantity of 16A Breaker	70pcs/type B ; 120pcs/type C @ 230Vac
Surge withstand resistance	L-N/2KV
Insulation and voltage resistance	3.0KV/60s/5mA
Starting time (at 230 V, 50 Hz, full loaded)	<0.5 s
Turn-off time (at 230 V, 50 Hz, full loaded)	<0.2 s
Ambient Temp (ta):	-20...+45°C
The maximum permissible track temperature under normal operating conditions:	45°C
Life time	100000 hours@35°C 50000 hours@45°C
Storage Temp: (ts):	-30...+75°C
Size LxWxH	196 x 31 x 45
Net weight:	120g

**Product size:**

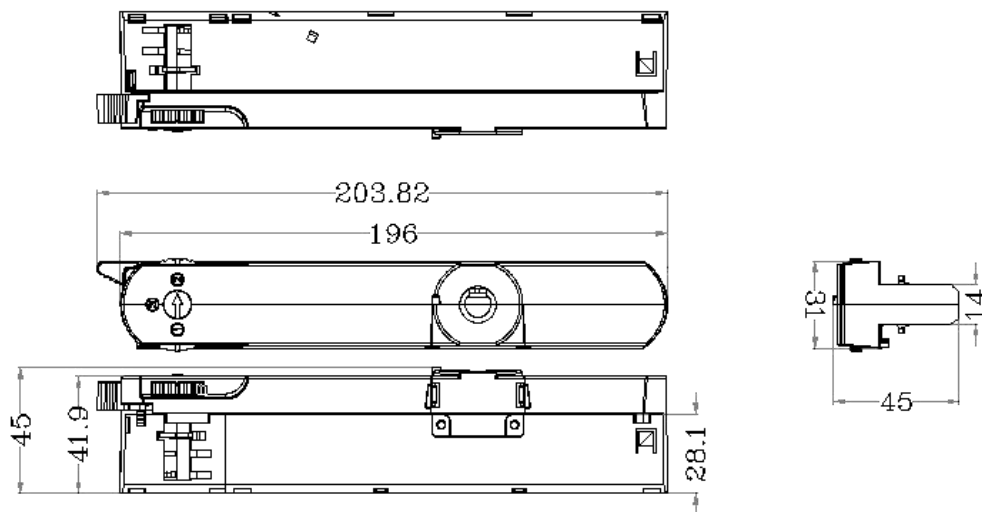

## Flicker Free Concealed Adaptor with Integrated LED Driver ( 3 Phase)

### Standards:

ENEC+CE: EN 55015: 2013/A1: 2015	CB : IEC 60570:2003	SAA: AS/NZS IEC61347.2.13.2013
EN 61000-3-2: 2014	IEC 60598-1:2014	AS/NZS 61347.1.2016
EN 61000-3-3: 2013	IEC 61347-1:2015	AS/NZS 60598.1:2017
EN 61347-1:2015	IEC 61347-2-13:2014	
EN 61347-2-13:2014/A1:2017	IEC 61347-2-13:2014/AMD1:2016	
EN 61547:2009		
EN 62384:2006/A1:2009		
EN 60598-1:2015		
EN 60570:2003		

### Glow-wire test

According to EN61347-1, pass 850°C temperature test.

### Over-load protection

If the output voltage range exceeded rated range, the LED Driver reduces the LED output current or in burst modes. After elimination of the overload the nominal operation is restored automatically.

### Short circuit protection

In case of a short circuit on the secondary side (LED) the LED Driver switched off. After elimination of the short-circuit fault the LED Driver will recover automatically.

### No-load protection

The LED Driver works in burst working mode to limit output voltage which allows the application to be able to work safely when LED string opens due to a failure.

### Under voltage protection

The LED Driver will switch off when input voltage is lower than 150-170VAC.

### Storage condition

Humidity 5%-85%

Non-Condensable

\*max. 60 days per year at 85 % humidity

### Storage temperature: -30 °C up to max. +75 °C

The devices have to be within the specified temperature range (ta) before they can be operated.

## Flicker Free Concealed Adaptor with Integrated LED Driver ( 3 Phase)

### Replace LED module

- Mains off
- Remove LED module
- Wait for 10 seconds
- Connect LED module again

**Hot plug-in or secondary switching of LEDs is not permitted and may cause a very high impulse current to the LEDs.**

Lamp isolation and electric strength test.

Electronic devices can be damaged by high voltage. This has to be considered during the routine testing of the luminaires in production..

According to IEC 60598-1 Annex Q or ENEC 303- Annex A,each lamp must be tested by 50VDC/1s isolation test.\* The isolation resistance must be at least 100MΩ.

As an alternative, IEC 60598-1 Annex Q describes a 2000V electric strength test.

### Installation instructions

Maximum loading: 50N ( Inclusive of the weight of luminaires and accessories ) / max torque: 2,5Nm

The LED module and all contact points within the wiring must be sufficiently insulated against 2 KV surge voltage. Air and creepage distance must be maintained.

### Wiring guidelines

#### Wiring type and cross section

The wire can be stranded wire and output wire can be 0.5 – 1.5 mm<sup>2</sup>.

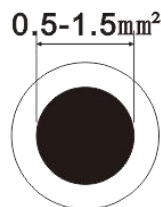

Photo a2

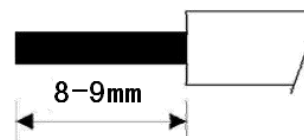

Photo 2

Strip 8-9 mm of insulation from the cable ends to ensure perfect operation of the wire terminals.Each terminal block only for one piece of wire.

**Flicker Free Concealed Adaptor with Integrated  
LED Driver ( 3 Phase)**

Item No.	Output current ( 230VAC Full load )	Input current ( 230VAC Full load )	Input load ( 230VAC Full load )	Output load range	PF (full load)	Efficiency (full Load)	Output voltage range
<b>SC18W180-450CG-4</b>	180mA	0.05A	8.8W	6.84W	0.80	80%	30-38V
	250mA	0.06A	11.8W	9.5W	0.90	82%	30-38V
	350mA	0.08A	16.2W	13.3W	0.92	82%	30-38V
	450mA	0.10A	20.2W	17.1W	0.92	82%	30-38V

All parameters are tested at 220VAC input, full load and 25°C ambient temperature after connected to power for 30 minutes.

**Expected life time**

Item No.	Output current	Ta	35°C	45°C
<b>SC18W180-450CG-4</b>	180mA	tc	50.9	60.8
		Life-time	100000H	50000H
	250mA	tc	58	69.4
		Life-time	100000H	50000H
	350mA	tc	63.2	73.6
		Life-time	100000H	50000H
	450mA	tc	69.6	78.2
		Life-time	100000H	50000H

\*The LED Drivers are designed for a life-time stated above under reference conditions and with a failure probability of less than 10 %.

**Flicker Free Concealed Adaptor with Integrated LED Driver ( 3 Phase)**

**Lamp screw type**

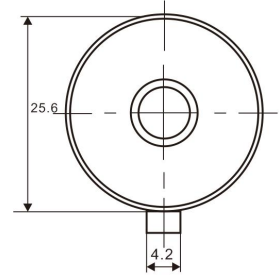
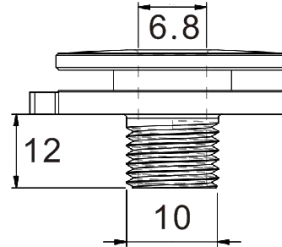
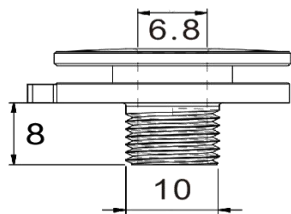

**DIP Switch Operation instructions (\*Hot-line working prohibited)**

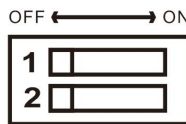

PIN1	PIN2	I <sub>rated</sub> [mA]	P <sub>rated</sub> [W]
OFF	OFF	180	6.84
ON	OFF	250	9.5
OFF	ON	350	13.3
ON	ON	450	17.1

**DIP switch parameters:**

- contact resistance (initial value):  $\leq 50\text{m}\Omega$
- contact resistance (after testing):  $\leq 100\text{m}\Omega$
- switching capacity (switches frequently switched): 25mA 24VDC
- switching capacity (switches not switched frequently): 100mA
- insulation resistance:  $\geq 100\text{M}\Omega$ .Min.at 500VDC
- dielectric strength: 500VAC Min. for 60 seconds.1mA
- interelectrode capacitance:  $\leq 5\text{PF}$
- operating force: 1000gf max
- electrical life: 3000 times

## Flicker Free Concealed Adaptor with Integrated LED Driver ( 3 Phase)

### Wiring guidelines

- All connections must be kept as short as possible to ensure good EMI behaviour.
- Mains leads should be kept apart from LED Driver and other leads (ideally 5 – 10 cm distance)
- Secondary switching is not permitted.
- Incorrect wiring can damage LED modules.
- The wiring must be protected against short circuits to earth.

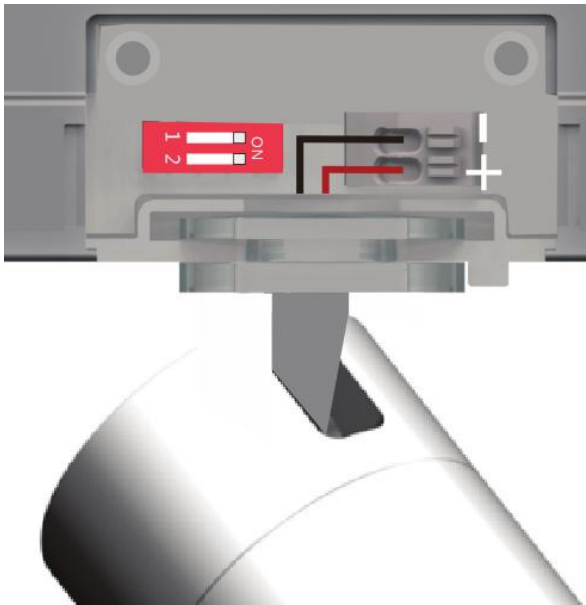

SC18W180-450CG-4 ( 180mA)

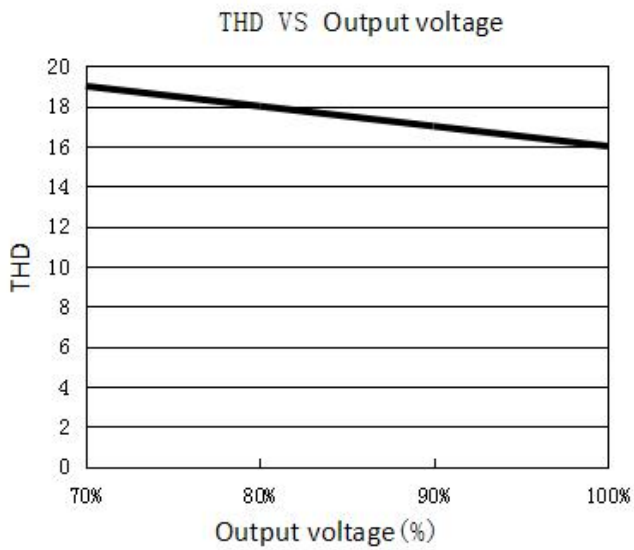
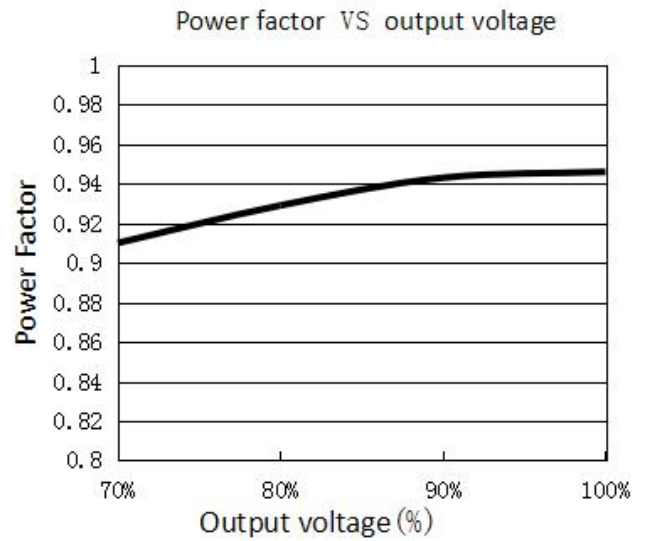
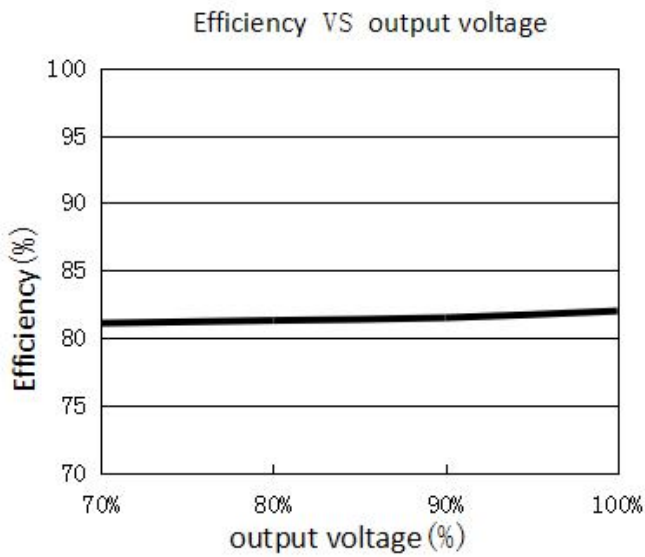



SC18W180-450CG-4 ( 250mA)

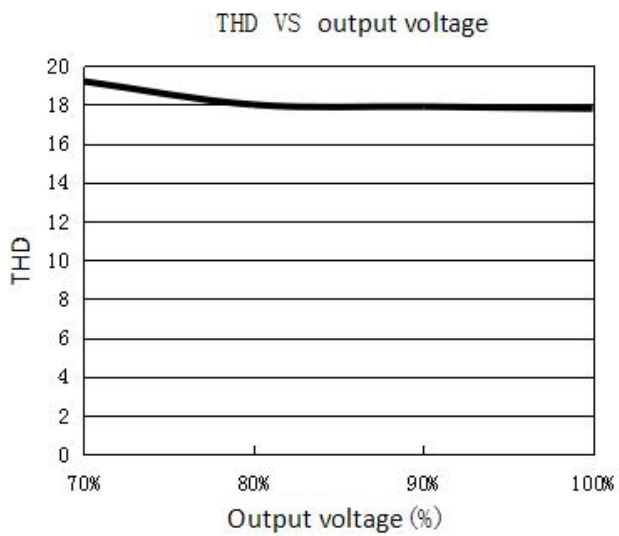
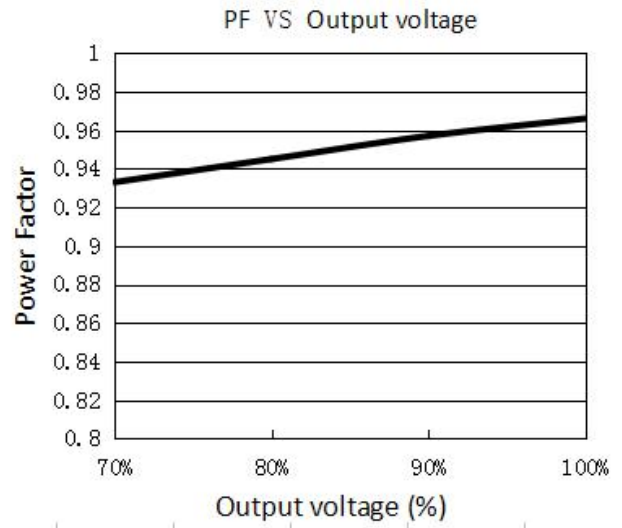
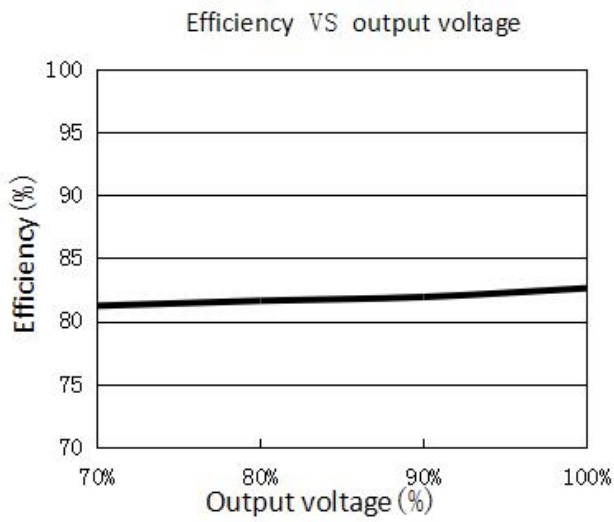

**Flicker Free Concealed Adaptor with Integrated LED Driver ( 3 Phase)**

**SC18W180-450CG-4 ( 350mA)**

Efficiency VS Output voltage

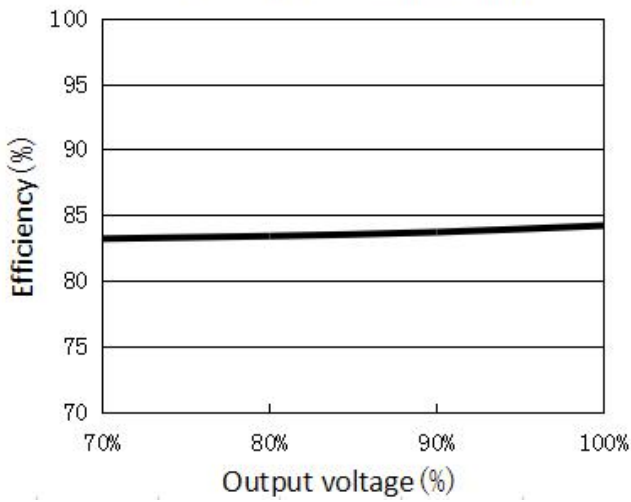

Power factor VS Output voltage

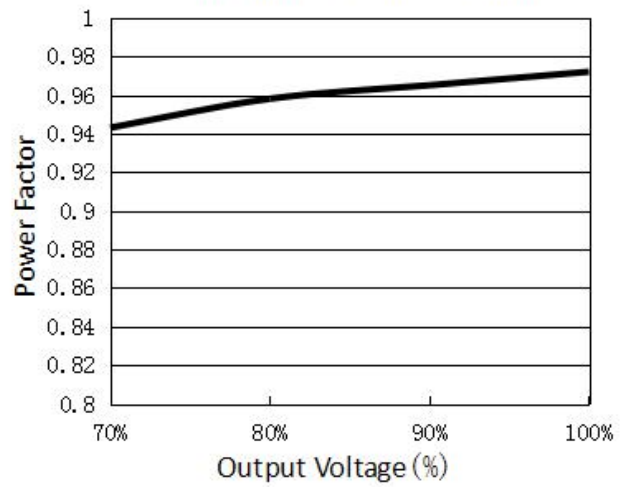

THD VS output voltage

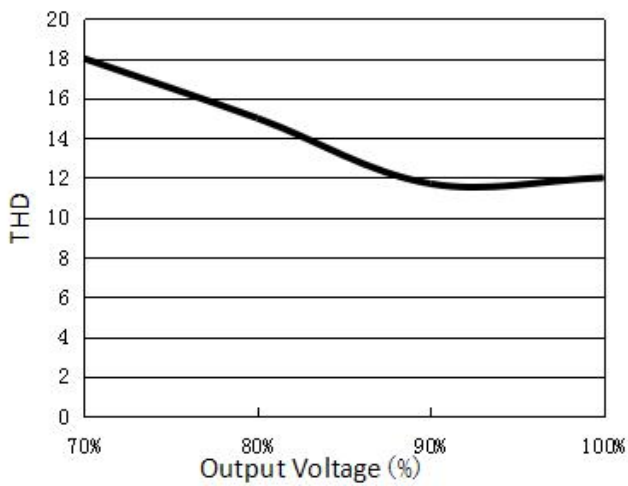

Flicker Free Concealed Adaptor with Integrated LED Driver ( 3 Phase)

SC18W180-450CG-4 ( 450mA)

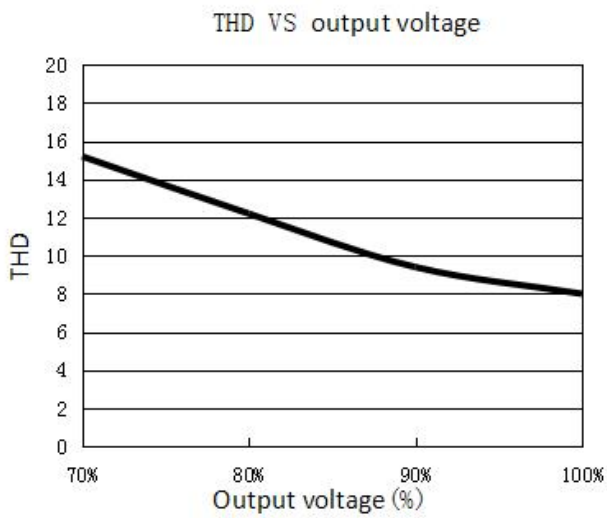
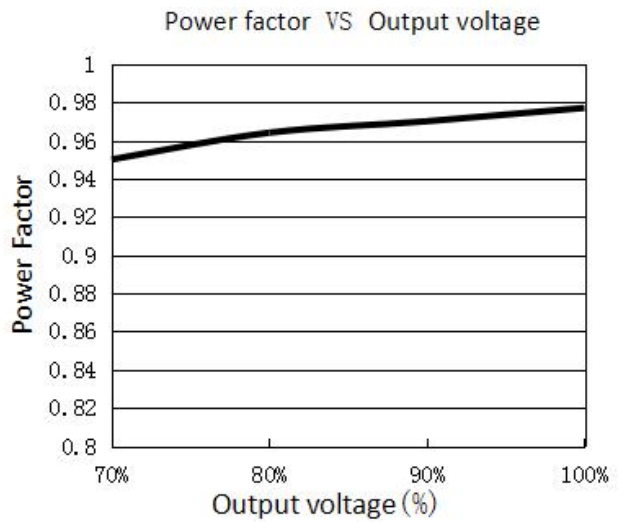
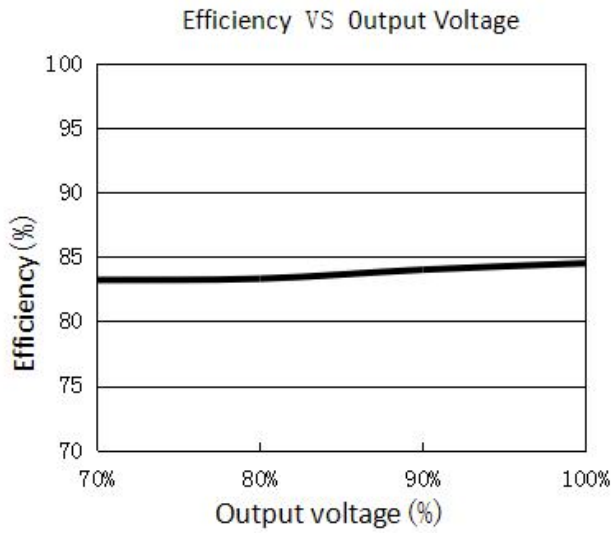

**Flicker Free Concealed Adaptor with Integrated LED Driver ( 3 Phase)**

Packing information:

Model	Carton L*W*H(mm)	Pcs/Carton	Net weight/ Pcs(kg)	Net weight/ Carton(kg)	Gross weight / Carton(kg)
SC18W180-450CG-4	515*274*370	100	0.12	12	13.5

3 Phase track light rail specification (for reference only):

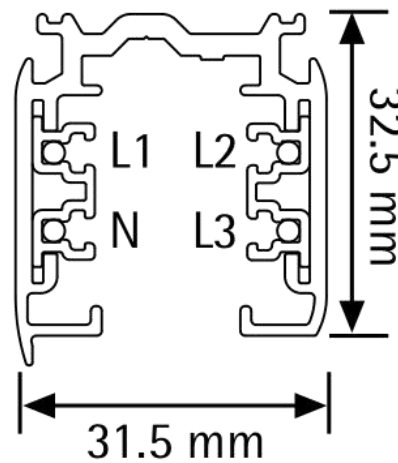

Lighting track adapter and rail system installation diagram (for reference only):



The adaptor shall be given that the use is limited to the track system specified.