

PHILIPS

CertaDrive

LED driver

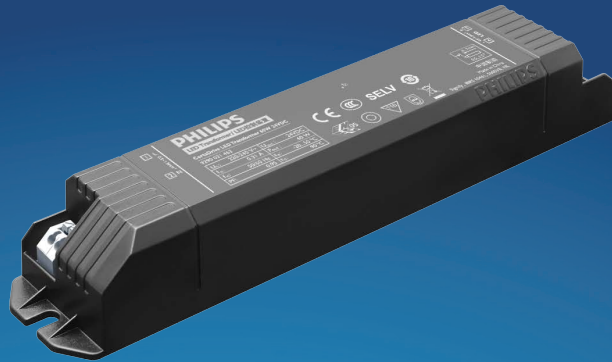

Datasheet

LED Transformers

CertaDrive LED Transformer 60W 24VDC

Product description

Philips full-electronic constant voltage LED Transformers are designed to operate 24VDC LED solutions used in general applications such as refrigerated display lighting, retail display lighting and linear accent lighting. They are specifically designed to ensure the highest performance with maximum robustness combined with a long lifetime.

Benefits

- SELV operating voltages, ensuring safety even if wiring or LED boards become damaged
- Energy savings through high efficiency
- Ultimate robustness, offering peace of mind and lower maintenance costs
- Easy to design-in and install
- Long lifetime

Features

- Built-in use for Insulation Class I and II applications
- Global approbations and certifications
- Stable output voltage
- Wide ambient temperature range
- Protection against overpower
- Output short-circuit shutdown feature with automatic restart

Application

- Retail display lighting, linear accent lighting and refrigerated display lighting
- Shelf lighting
- Cove lighting
- Facade accent lighting
- Coolers and freezers

Electrical input data

Specification item	Value	Unit	Condition
Rated input voltage range	220...240	Vac	Performance
Rated input voltage range	198...264	Vac	Operational safety
Rated input frequency	50...60	Hz	Performance
Rated input frequency	45...66	Hz	Operational safety
Rated input current	0.31	A	
Rated input power	69	W	
Power factor	0.95		
Total harmonic distortion	<20	%	
Efficiency (typ)	86.5	%	

Electrical output data

Specification item	Value	Unit	Condition
Regulation method	Constant Voltage		Rated output voltage = 24VDC
Output voltage range	22.8...25.2	Vdc	@ output current range 1.5 ... 2.5A
Output current range	0.25...2.5	Adc	
Output voltage ripple	< 2400	mV _{pp}	
Rated output power	60	W	Min output power 6W
Line regulation	< 3	%	
Load regulation	< 5	%	
Turn-on delay	≤ 1	s	
Output voltage rise time	≤ 100	ms	
Hold-up time	≥ 10	ms	

Logistical data

Specification item	Value
Product name	CertaDrive LED Transformer 60W 24VDC
Order code	749460 00
Logistic code 12NC	9290 021 46380
Pieces per box	20

Wiring & Connections

Specification item	Value	Unit	Condition
Input wire cross-section	0.5...1.5	mm ²	Solid and stranded wire
Input wire strip length	6...7	mm	
Output wire cross-section	0.5...1.5	mm ²	Solid and stranded wire
Output wire strip length	6...7	mm	
Maximum output cable length	1.0	m	CISPR15: between driver and LED module

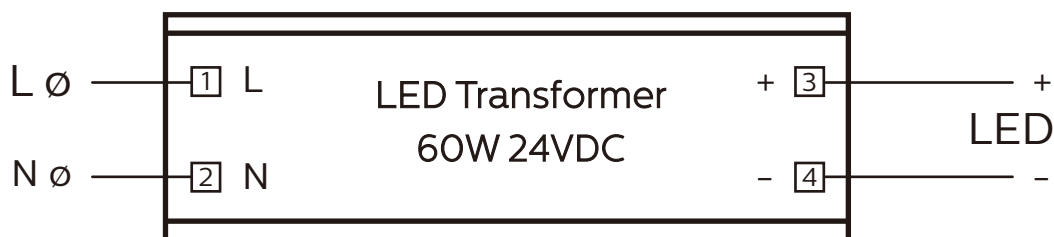

Insulation

Insulation	Mains	LED
Mains		SELV (double)
LED	SELV (double)	

Dimensions and weight

Specification item	Value	Unit	Condition
Length (A1)	211.0	mm	
Width (B1)	40.0	mm	
Height (C1)	32.0	mm	
Fixing hole distance (A2)	200.0	mm	Fixing hole diameter: 4.2 mm
Weight	225	gram	

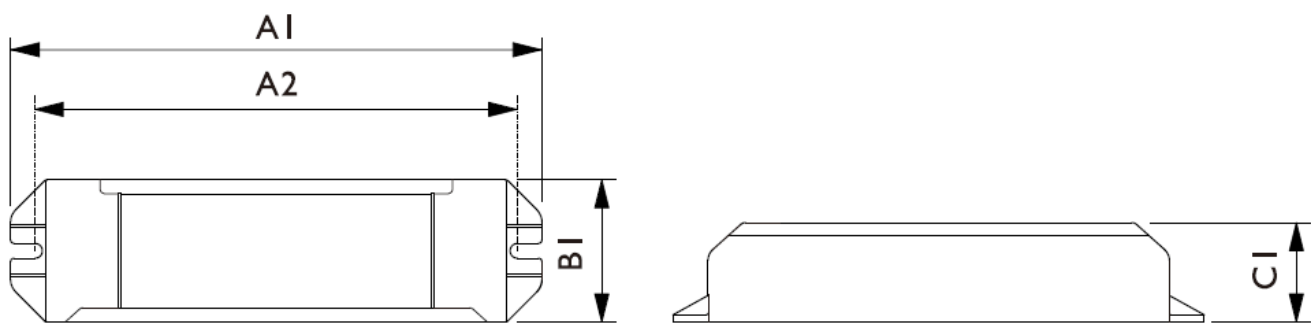

Operational temperatures and humidity

Specification item	Value	Unit	Condition
Driver ambient temperature	-20...+50	°C	At rated output power. Higher ambient temperature allowed as long as Tcase-max is not exceeded.
Tcase-min	-20	°C	
Tcase-max	90	°C	Max. steady-state Tcase
Tcase-life	80	°C	For rated driver lifetime
Maximum housing temperature	110	°C	In case of failure
Relative humidity	10...90	%	Non-condensing
Ingress Protection*	IP20		
Noise and hum	≤ 20	dB	

* : The LED Transformer is primarily intended for built-in use. It must not be exposed including but not limited to snow, water and ice or any other chemical agent which may have an adverse affect on driver operation and performance. Exposure may lead to driver failure. It is the luminaire manufacturer's/installer's responsibility to prevent exposure.

Storage temperature and humidity

Specification item	Value	Unit	Condition
Ambient temperature	-20...+80	°C	
Relative humidity	5...95	%	Non-condensing

Lifetime

Specification item	Value	Unit	Condition
Rated driver lifetime	30,000	hours	$T_{case} \leq T_{case-life}$. Maximum failures = 10%. See graph.

Features

Specification item	Value	Remark	Condition
Open load protection	Yes		U_{out} (open circuit) = 35V max
Short circuit protection	Yes		Hiccup mode, automatic recovering
Over power protection	Yes		Automatic recovering
Overheating protection	Yes		
Hot wiring	Yes		
Suitable insulation class applications	I and II		Per IEC60598

Certificates and standards

Specification item	Value
Approval marks	CE / CB / CCC / SELV / 110 / Double-insulated / ENEC

Inrush current

Specification item	Value	Unit	Condition
Inrush current I_{peak} (typ)	5.5	A	Input voltage 240Vac
Inrush current T_{width} (typ)	60	μs	Input voltage 240Vac, measured at 50% I_{peak}
Max. recommended number of drivers	28	pcs	MCB 16A B type, mains impedance 200m Ω + 400 μH

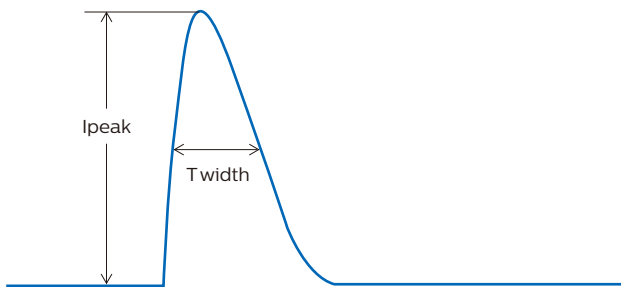

MCB	Rating	Relative number of drivers*
B	6A	37%
B	10A	63%
B	13A	81%
B	16A	100%
B	20A	125%
B	25A	156%
C	6A	63%
C	10A	104%
C	13A	135%
C	16A	170%
C	20A	208%
C	25A	260%
D	6A	125%
D	10A	104%
D	13A	135%
D	16A	170%
D	20A	208%

* : please check that cable cross sectional area corresponds with MCB rating and type

Surge immunity

Specification item	Value	Remark	Condition
Mains surge immunity (diff. mode)	1	kV	L-N, acc. IEC61000-4-5. 2 Ohm, 1.2/50 μs , 8/20 μs

Graphs

Power factor versus output power

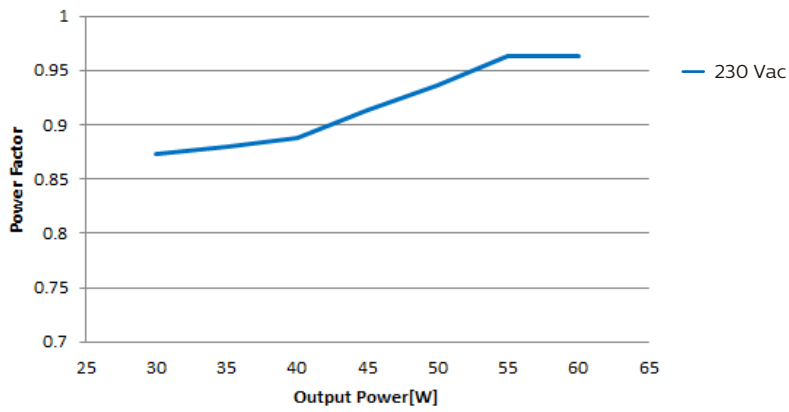

Efficiency versus output power

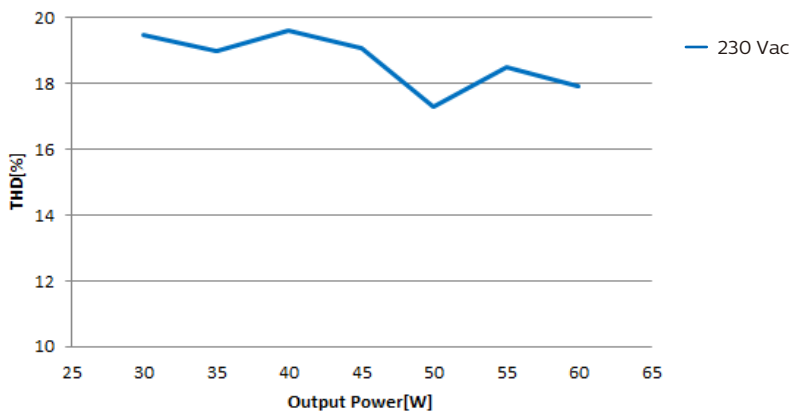

THD versus output power

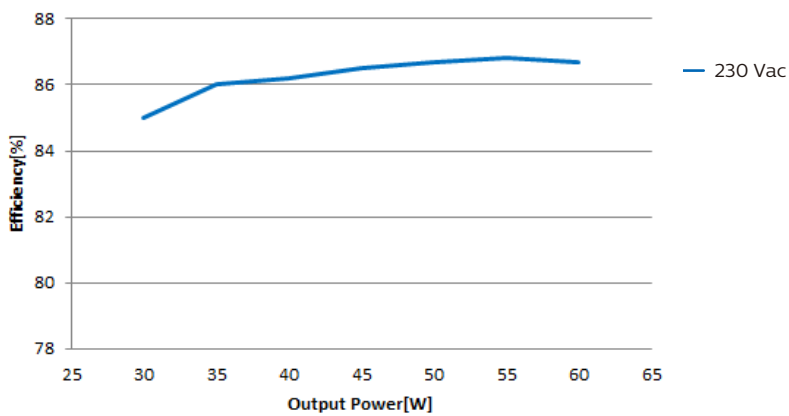

Driver lifetime versus Tc temperature

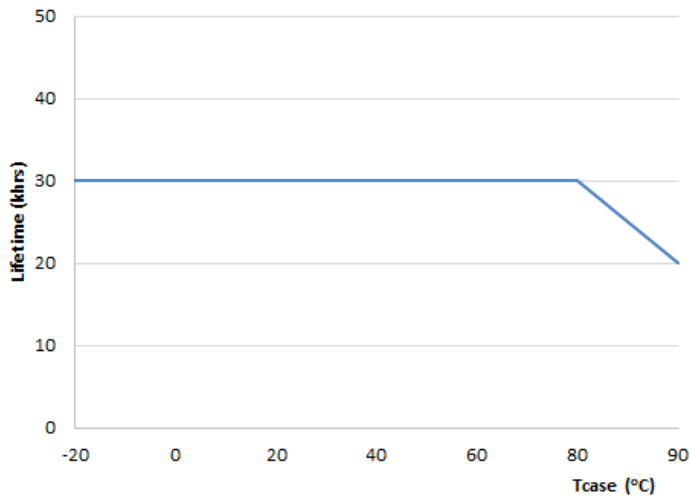

© 2018 Signify Holding, IBRS 10461, 5600VB, NL. All rights reserved.

The information provided herein is subject to change, without notice. Signify does not give any representation or warranty as to the accuracy or completeness of the information included herein and shall not be liable for any action in reliance thereon. The information presented in this document is not intended as any commercial offer and does not form part of any quotation or contract, unless otherwise agreed by Signify. Philips and the Philips Shield Emblem are registered trademarks of Koninklijke Philips N.V. All other trademarks are owned by Signify Holding or their respective owners.

Date of release: July 08, 2019

www.philips.com