



## Datasheet

### Xitanium track adaptor drivers (3C)

Xi 42W/a 0.9-1.05A 40V DS 3CG 230V

9290 028 50380

#### Affordable and reliable LED Drivers

Affordable LED driver range offering Philips reliability. The Xitanium track driver range is compatible with COB and mid-power LEDs from any LED manufacturer.

#### Benefits

- Driver design based on Philips experience and knowledge of conventional fluorescent and HID technologies
- Various power ratings matching common lumen packages/applications
- Track adaptor housing design for compact track luminaire designs

#### Features

- Compact size
- Specific, optimized dual-output current choice
- Long lifetime
- Low output current ripple, low input current THD
- Suitable for 3-phase track systems
- Available in white, black and grey housing color

#### Application

- Public buildings (airports, cinemas, theaters, exhibition halls)
- Retail (supermarkets, shops)
- Offices

## Electrical input data

Specification item	Value	Unit	Condition
Rated input voltage range	220...240	V <sub>ac</sub>	Performance range
Rated input voltage	230	V <sub>ac</sub>	
Rated input frequency range	50...60	Hz	Performance range
Rated input current	0.27	A	@ full output power @ rated input voltage
Rated input power	47	W	@ rated output power @ rated input voltage
Power factor	0.9		@ full output power @ rated input voltage
Total harmonic distortion	20	%	@ rated output power @ rated input voltage
Efficiency	89.5	%	@ rated input voltage @ rated output power
Input voltage AC range	198...264	V <sub>ac</sub>	Safety operational range
Input frequency AC range	45...66	Hz	Safety operational range
Isolation input to output	SELV		

## Electrical output data

Specification item	Value	Unit	Condition
Regulation method	Constant Current		
Output voltage	30...40	V <sub>dc</sub>	
Output voltage max.	60	V	Maximum output voltage (rms)
Output current	0.9 / 1.05	A	Select output current via the dipswitches
Output current tolerance ±	8	%	
Output current ripple LF	≤ 4	%	Ripple = peak / average, < 3kHz
Output current ripple HF	≤ 15	%	
Output P <sub>st</sub> <sup>LM</sup>	≤ 0.02		
Output SVM	≤ 0.07		
Output power	27...42	W	

## Electrical data controls input

Specification item	Value	Unit	Condition
Control method	Fixed		Set output current via DipSwitch

## Wiring and Connections

Specification item	Value	Unit	Type
Output wire cross-section	0.5...1.5	mm <sup>2</sup> / AWG	solid / stranded wire
Output wire strip length	8.5...9.5	mm	
Maximum cable length	0.3	m	Total length of wiring including LED module, one way

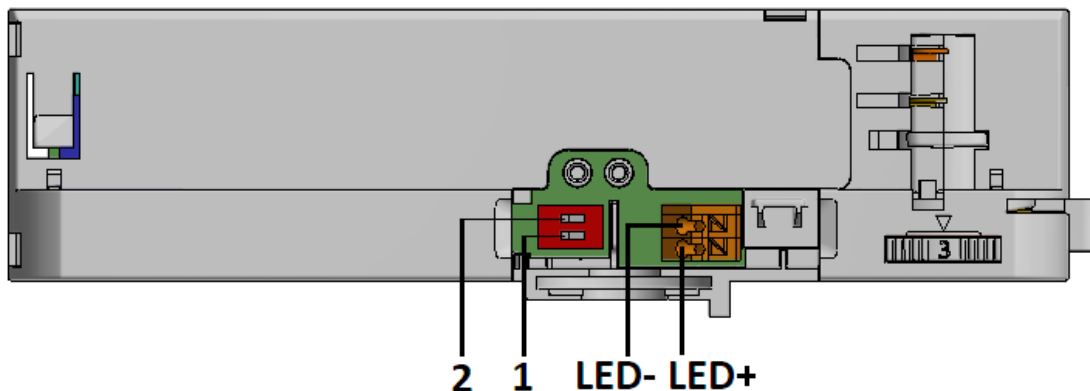

## Insulation

Insulation per IEC61347-1	Input	Output
Input		SELV
Output	SELV	

## Dimensions and weight

Specification item	Value	Unit	Tolerance (mm)
Length (A1)	162	mm	
Mounting hole distance (A2)	67.9	mm	
Width (B1)	31	mm	
Width (B2)	33.8	mm	
Height (C1)	41.4	mm	
Height (C2)	13.6	mm	
Weight	130	gram	
Housing color	White (RAL 9003)		

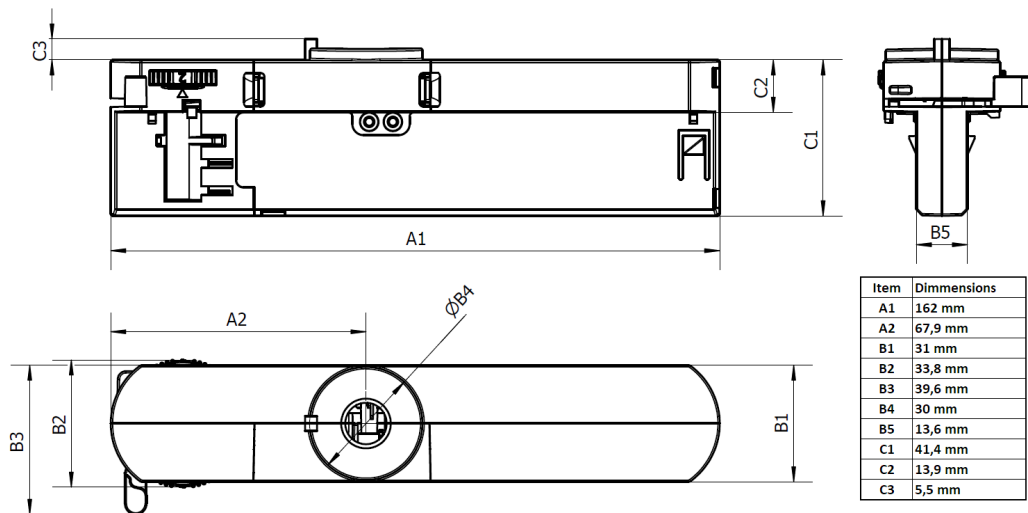

## Logistical data

Specification item	Value
Product name	Xi 42W/a 0.9-1.05A 40V DS 3CG 230V
Logistic code 12NC	9290 028 50380
Pieces per box	80

## Operational temperatures and humidity

Specification item	Value	Unit	Condition
Ambient temperature	-20...+35	°C	Higher ambient temperature allowed as long as T <sub>case-max</sub> is not exceeded
T <sub>case-max</sub>	85	°C	Maximum temperature measured at T <sub>case-point</sub>
T <sub>case-life</sub>	75	°C	Measured at T <sub>case-point</sub>
Maximum housing temperature	130	°C	In case of a failure, inherent by design
Relative humidity	10...90	%	Non-condensing

## Lifetime

Specification item	Value	Unit	Condition
Driver lifetime	50,000	hours	Measured temperature at Tcase-point is Tcase-life. Maximum failures = 10%

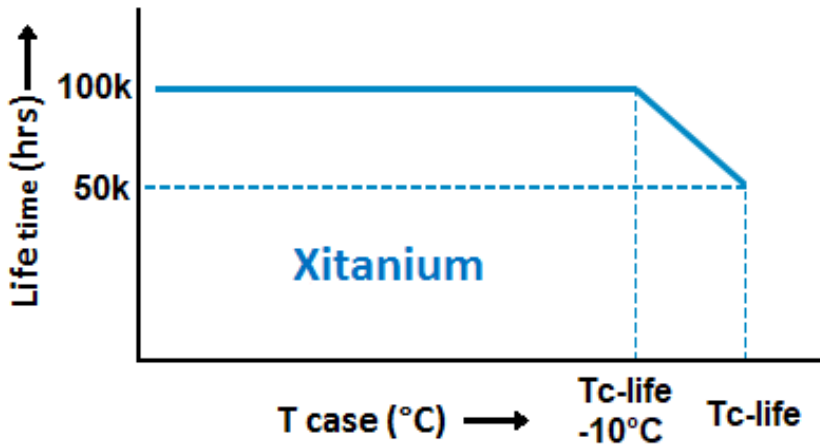

## Storage temperature and humidity

Specification item	Value	Unit	Condition
Ambient temperature	-25...+85	°C	
Relative humidity	5...95	%	Non-condensing

## Programmable features

Specification item	Available	Default setting	Condition
Set Adjustable Output Current (AOC)	DipSwitch	1050 mA	Set the output current via the dipswitches, see wiring diagram for an overview

## Features

Specification item	Value	Condition
Open load protection	Yes	Automatic recovering
Short circuit protection	Yes	Automatic recovering
Over power protection	Yes	Automatic recovering
Hot wiring	No	
Suitable for fixtures with protection class	I	per IEC60598

## Inrush current

Specification item	Value	Unit	Condition
Inrush current	14.3	A	Input voltage V
Inrush peak width	236	$\mu$ s	Input voltage V, measured at 50% height
Drivers / MCB 16A type B	$\leq 35$	pcs	Indicative value

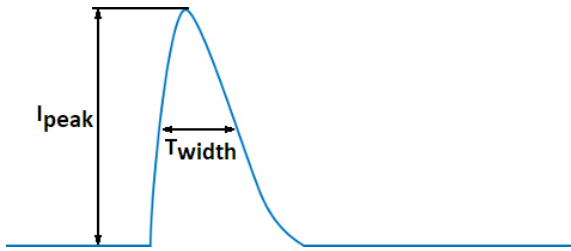

Please refer to the driver design in guide if you use other MCB-types.

## Driver touch current / protective conductor current

Specification item	Value	Unit	Condition
Typical Touch Current (ins. Class II)	0.7	mA peak	Acc. IEC61347-1. LED module contribution not included

## Surge immunity

Specification item	Value	Unit	Condition
Mains surge immunity (diff. mode)	1	kV	Acc. IEC61000-4-5. 2 Ohm, 1.2/50 $\mu$ s, 8/20 $\mu$ s
Mains surge immunity (comm. mode)	2	kV	Acc. IEC61000-4-5. 12 Ohm, 1.2/50 $\mu$ s, 8/20 $\mu$ s

## Application Info

Specification item	Value
Approval marks	CE / CQC / EAC / ENEC / RCM / SELV / WEEE
Ingress Protection classification (IP)	20
Application	Indoor Point
Mounting Type	Track mounting

## Graphs

### Operating window

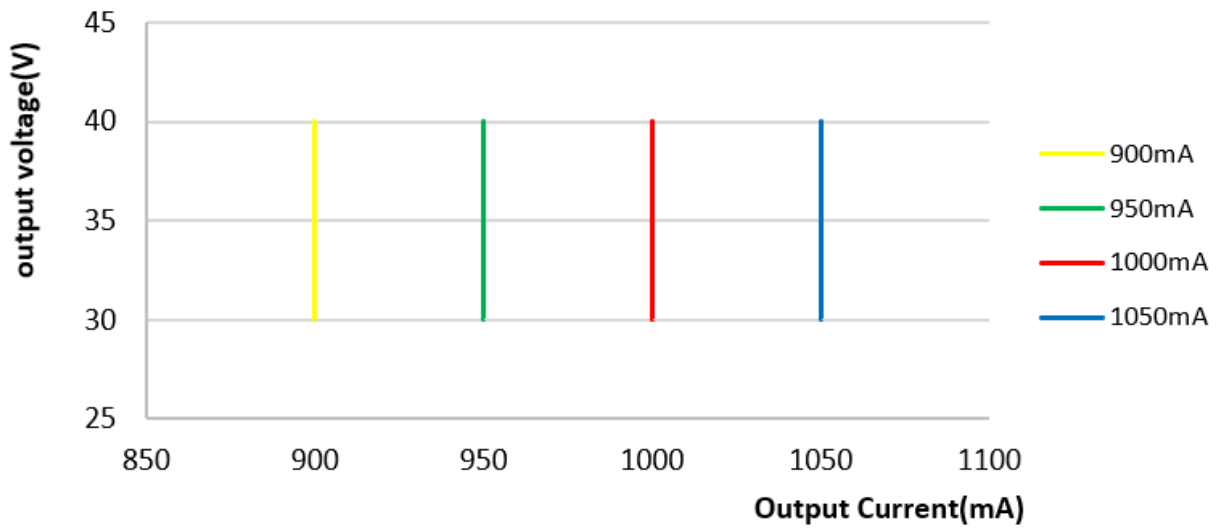

### Power factor versus output power

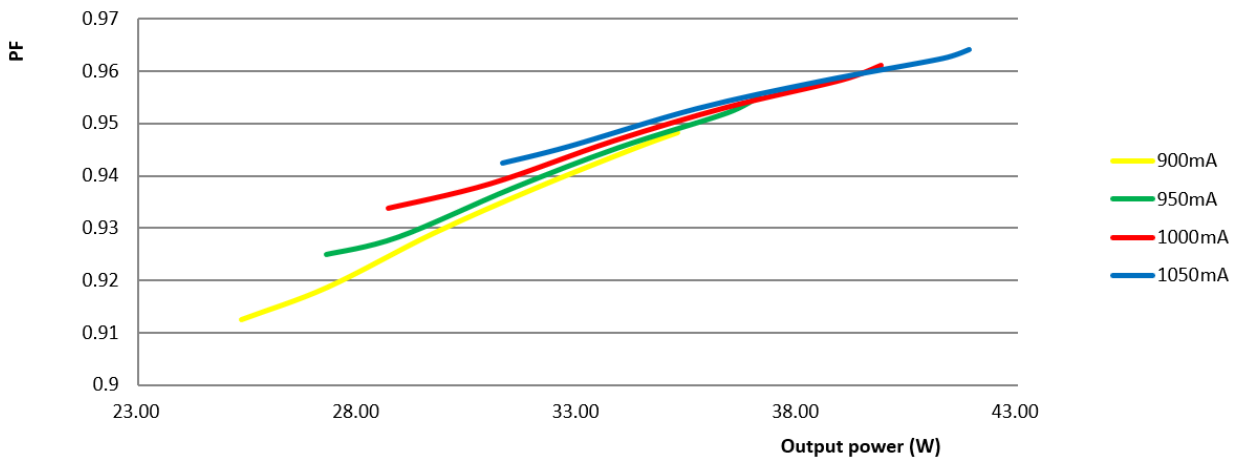

### Efficiency versus output power

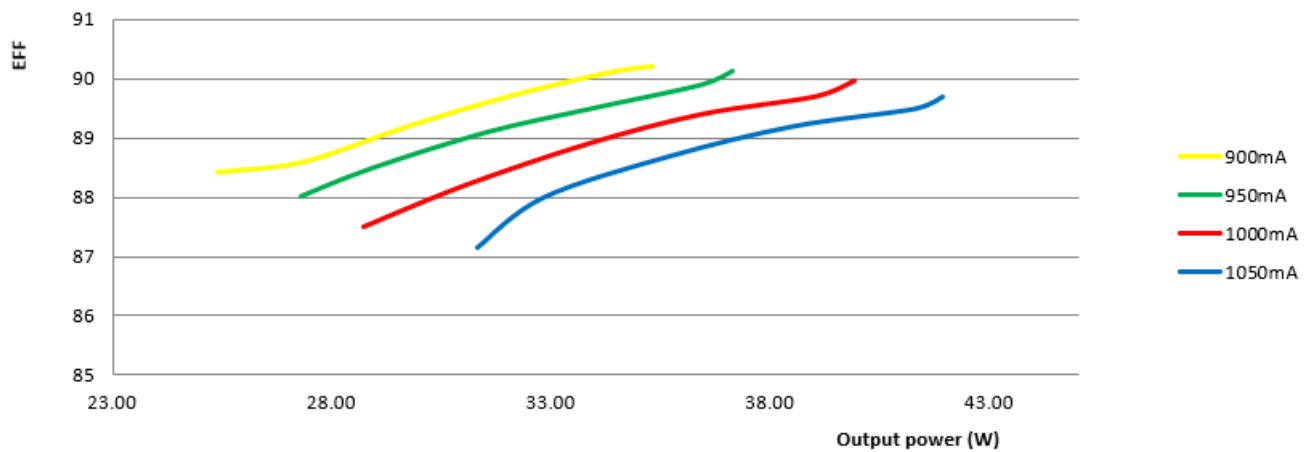

## THD versus output power

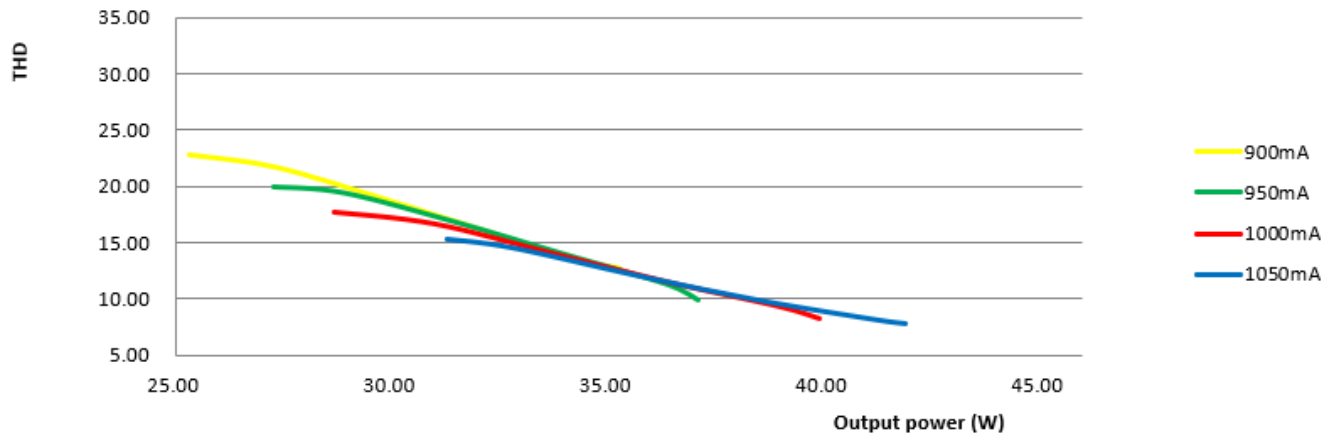

## Notes

The adapter is compatible with Global Trac Pro, Stucchi OneTrack 3 Circuit tracks.



©2021 Signify Holding, IBRS 10461, 5600 VB, NL. All rights reserved.  
UK importer address: Signify Commercial UK Limited, 3, Guildford Business Park, GU2 8XG.

The information provided herein is subject to change without notice. Signify does not give any representation or warranty as to the accuracy or completeness of the information included herein and shall not be liable for any action in reliance thereon. The information presented in this document is not intended as any commercial offer and does not form part of any quotation or contract, unless otherwise agreed by Signify.

Philips and the Philips Shield Emblem are registered trademarks of Koninklijke Philips N.V. All other trademarks are owned by Signify Holding or their respective owners.

Date of release: August 27, 2021 v2

[www.philips.com/oem](http://www.philips.com/oem)